

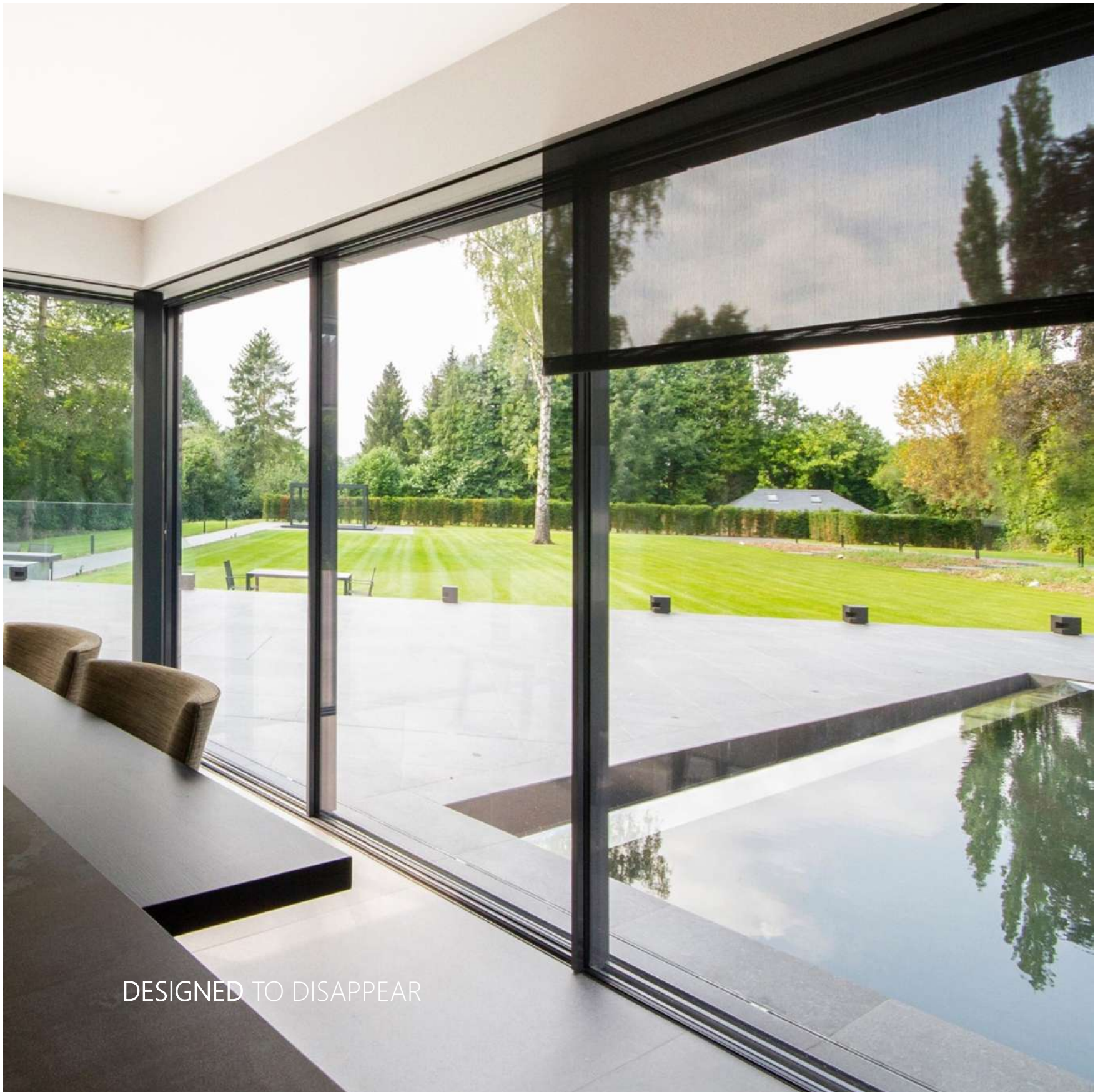

BL'NDSPACE®
BLINDS CONCEALMENT SYSTEM



DESIGNED TO DISAPPEAR



DESIGN. NOT DISTRACTION.

Working with the Blindspace® concealment system means creating environments where products for privacy, shading, room darkening, temperature and glare control can be fully hidden when not required. Any window can be prepared for future installation of concealed blinds, resulting in clutter-free designs and timeless style.

ANY BLIND. ANY SIZE.

Blindspace develops all of its products in Sweden, based on input and feedback from leading architects, designers, window treatment manufacturers, shading specialists and installers. Together with partners in more than 25 countries, Blindspace continuously develops new solutions and resources to simplify the inclusion of concealed blinds in any project.



FUTURE PROOF

With Blindspace you can enable manual or motorised blinds to be installed at any time without intruding on the design. If you could, why wouldn't you?



1. SPECIFICATION

The architect and their client, together with a local shading specialist agree what blinds to prepare for, as early as possible in the project.



2. CONSTRUCTION

Concealment boxes are ordered through the shading specialist and assembled with electrical wiring, during construction of the building.



3. BLINDS INSTALLATION

The hidden space for the blinds is accessed at any time, blinds are surveyed and fitted when construction work and decoration is completed.

CONFIGURATIONS



SINGLE BLINDS Page 08-09

The single blinds configuration comprises of a head box installed inside the wall or ceiling, accessible for the installation of blinds at any time.



BLACKOUT BLINDS Page 10-11

Blackout blinds with side channels can be hidden using a head box, two side boxes and an optional bottom hem bar box.



DUAL BLINDS Page 12-13

Combine blinds for privacy, shading, blackout, or an insect screen using a larger head box with optional side boxes and bottom hem bar box.



CORNER BLINDS Page 14-15

Combine the softness of curtains with the functionality of blackout blinds. Blinds concealed with boxes and curtain tracks recessed into ceiling.



BLINDS & CURTAINS Page 16-17

Combine the softness of curtains with the functionality of blackout blinds. Blinds concealed with boxes and curtain tracks recessed into ceiling.



SHAPED BLINDS Page 18-21

Shaped blinds concealed using custom boxes and pelmets powder coated to match glazing structure or walls. Multiple configurations available.



SKYLIGHT BLINDS Page 22-25

Blinds for skylights of all sizes can be concealed using a frame of boxes around the opening. Multiple configurations available.



SPECIALITY BLINDS Page 26-27

Custom Blindspace® concealment boxes can be made to measure for any type of blinds in any type of window.

FEATURES



PRODUCT FEATURES & FAQ Page 28-30

Read more about the reasons to use aluminium boxes to conceal blinds and the benefits of using Blindspace for your project.



AVAILABLE RESOURCES Page 31

Access size charts, technical drawings, product datasheets, installation instructions, samples and more on our webpage www.blindspace.com

SYSTEM DETAILS

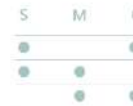

SYSTEM OVERVIEW Page 32

Comparison table showing the various features of Blindspace® Standard, Modular and Custom box Series.

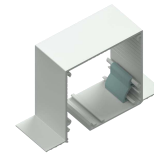

STANDARD S SERIES Page 33-34

Blindspace® S Series is our standard concealment box made in two sizes 100x100 and 130x130mm, to hide blinds with minimal visual impact.



MODULAR M SERIES Page 35-36

Blindspace® M Series is a superior concealment box with black anodized interior to minimize light transmission and external faces powder coated to specified RAL colour.

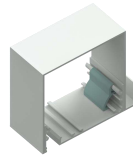

CUSTOM C SERIES Page 37-38

Blindspace® C Series boxes can be made to any size, to conceal any type of blind, in any type of window, for minimal visual impact.

COMPANY



ABOUT BLINDSPACE Page 39

Created in Sweden with the objective to design architectural solutions that make blinds and curtain tracks disappear.

SINGLE BLINDS



The single blinds configuration comprises of a head box installed inside the wall or ceiling, accessible for the installation of blinds at any time. Depending on the window and protruding handles, blinds can come out on the window side of the box or on the room side. Most often multiple motorised blinds are being installed, one after the other, operated independently or together.

SAMPLE DRAWINGS

EXAMPLE 1

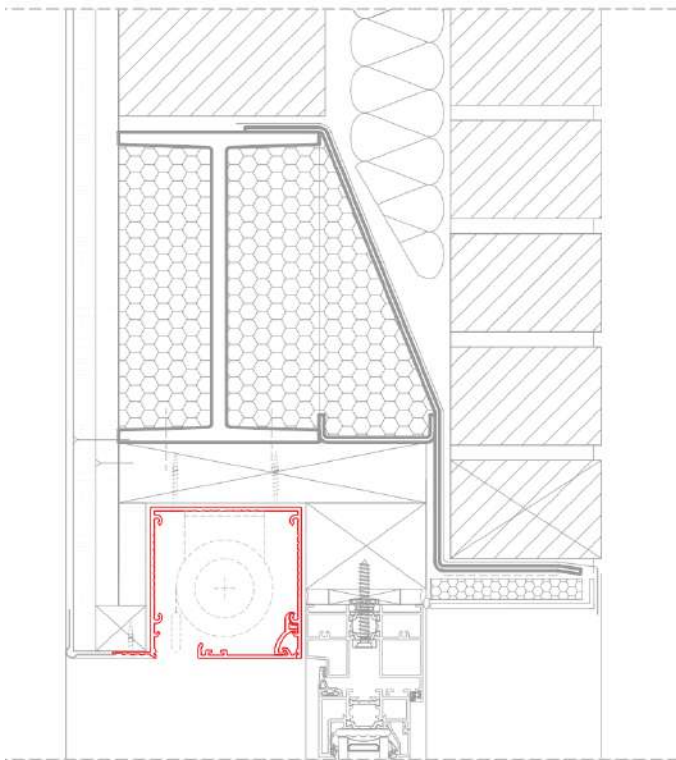

EXAMPLE 2

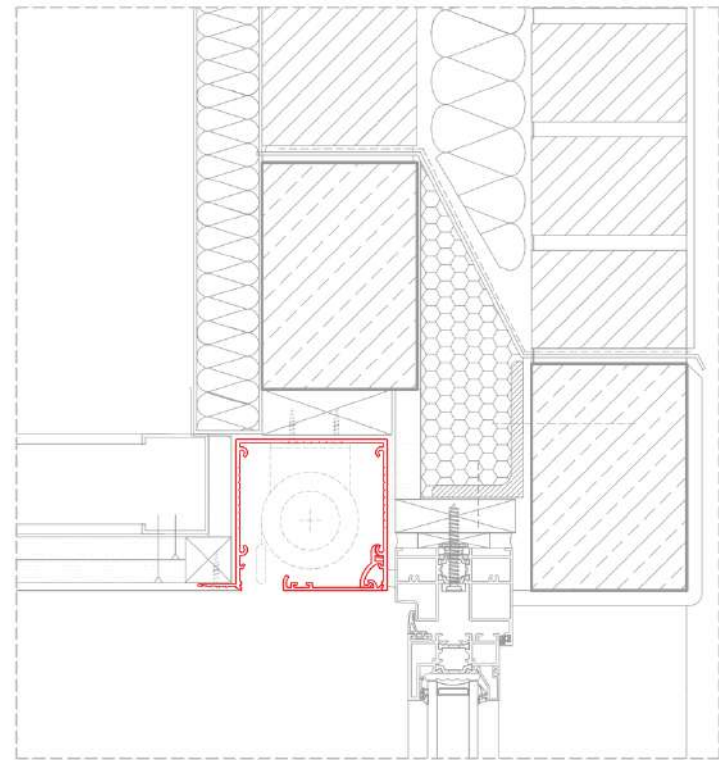

BLACKOUT BLINDS



For the best room darkening, window blinds are made with blackout fabric and side channels. To prepare a window for concealed blackout blinds, boxes need to be installed on three or all four sides of the window. All boxes have the same width, creating an even frame around the window. The extra space inside side boxes is also used when installing the blind that is wider than the window opening, inside the head box.

SAMPLE DRAWINGS

HEAD BOX

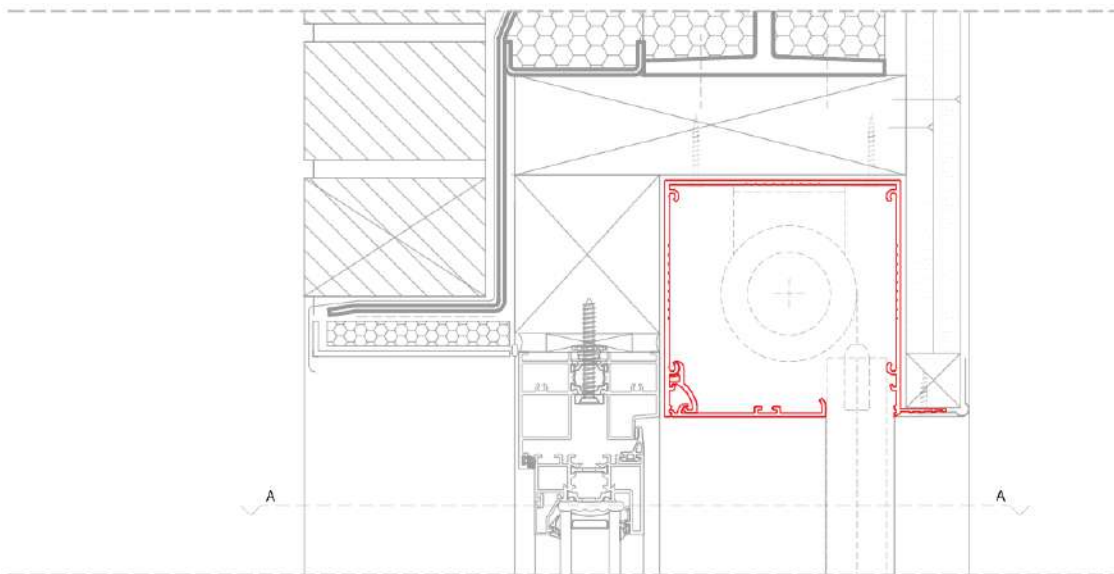

SIDE BOX

SECTION A-A

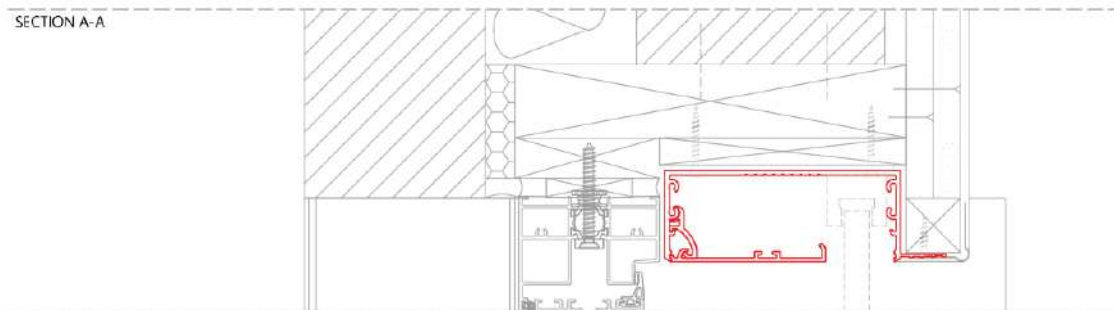

DUAL BLINDS



Two separate blinds can be hidden together in both small and large windows. This can be two free-hanging blinds, one free-hanging and one with side channels, or two blinds both with side channels. Combinations may be for: Privacy + Blackout, Shading + Blackout, or Shading + Flyscreen. Depending on the objective, dual blinds can be concealed using head box only, head box and side boxes or with boxes on all sides of the window.

SAMPLE DRAWINGS

EXAMPLE 1: SIDE-BY-SIDE

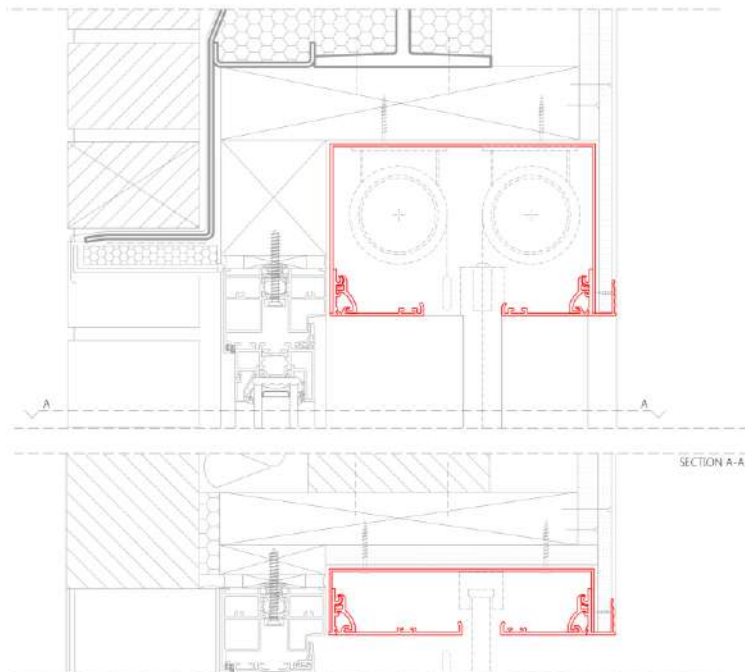

EXAMPLE 2: STACKED

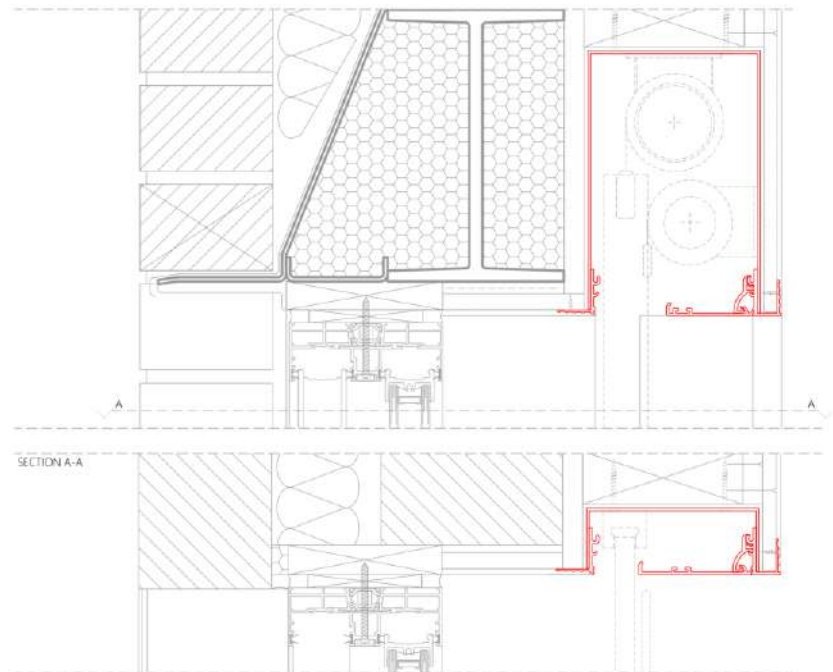

CORNER BLINDS



Floating corners are becoming increasingly popular in high-end residential projects. The most common configuration for concealed blinds in corner windows, is single roller blinds in either mitred boxes or butt-jointed boxes. Blinds can be facing the window or the room, with the latter producing the smallest gap between the two blinds. There are also specialist blinds available that zip together in the corner for no gap.

SAMPLE DRAWINGS

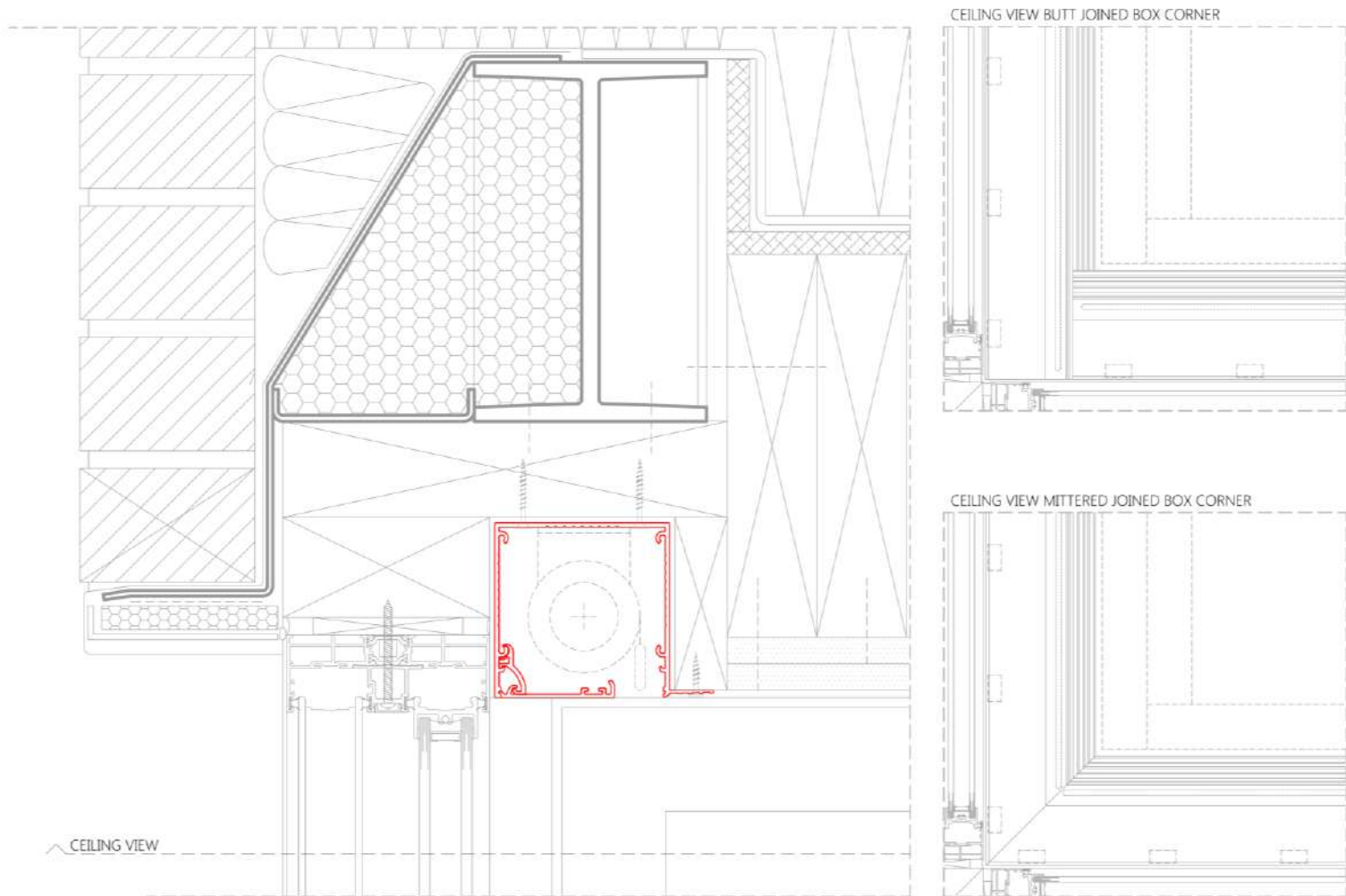

BLINDS & CURTAINS

SEE SEPARATE BROCHURE ABOUT RECESSED CURTAIN TRACKS



Blinds and curtains are often combined and we have developed systems to recess manual and electric curtain tracks from popular manufacturers to maintain a clean design. Curtain tracks can be installed on their own or next to single blinds, blackout blinds, dual blinds and in corners using curved curtain tracks. Dual curtain tracks can also be used to allow for two sets of curtains to be hung at the same window.

SAMPLE DRAWINGS

EXAMPLE 1

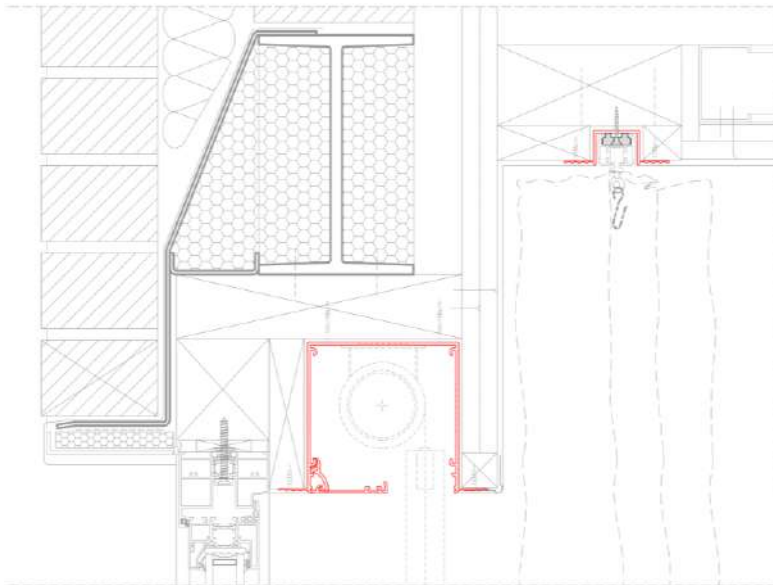

EXAMPLE 2

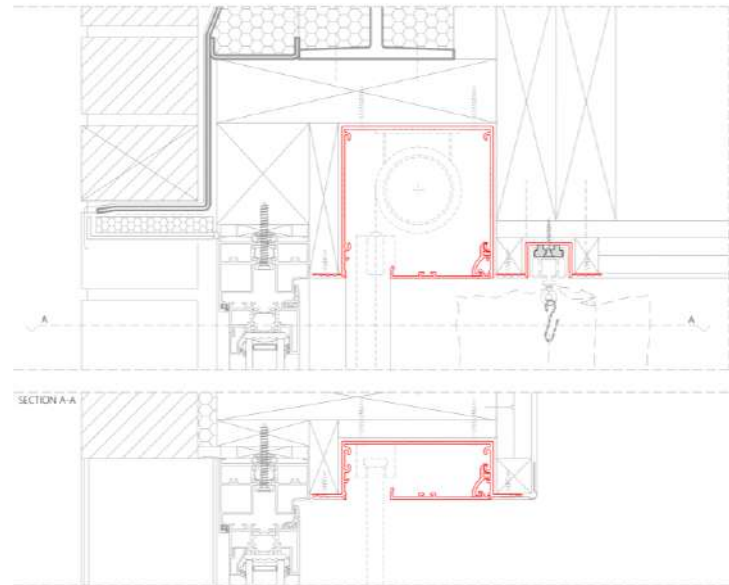

SHAPED BLINDS (Bottom-Up)

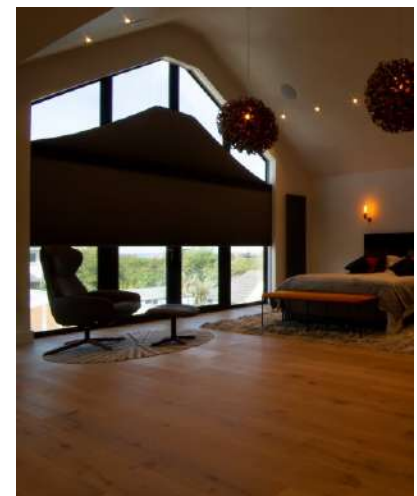
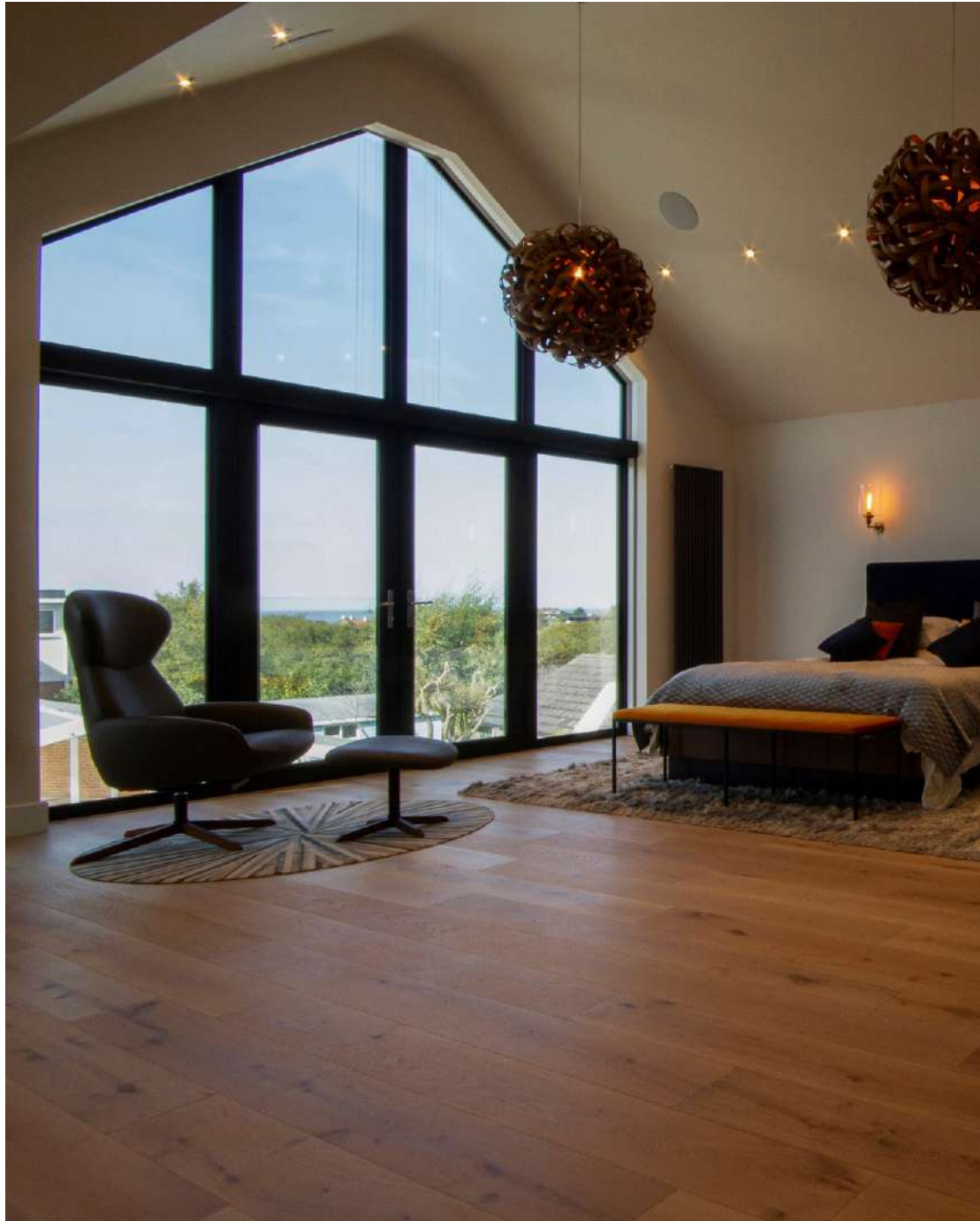

There are specialist blind systems developed for gable end windows following a roof structure and other feature windows. Bottom-up blinds can be concealed above sliding doors in bespoke boxes and pelmets, or in the floor, to be pulled up using thin wires or side channels. This can be either roller blinds or cellular blinds that take up less space when concealed.

SAMPLE DRAWINGS

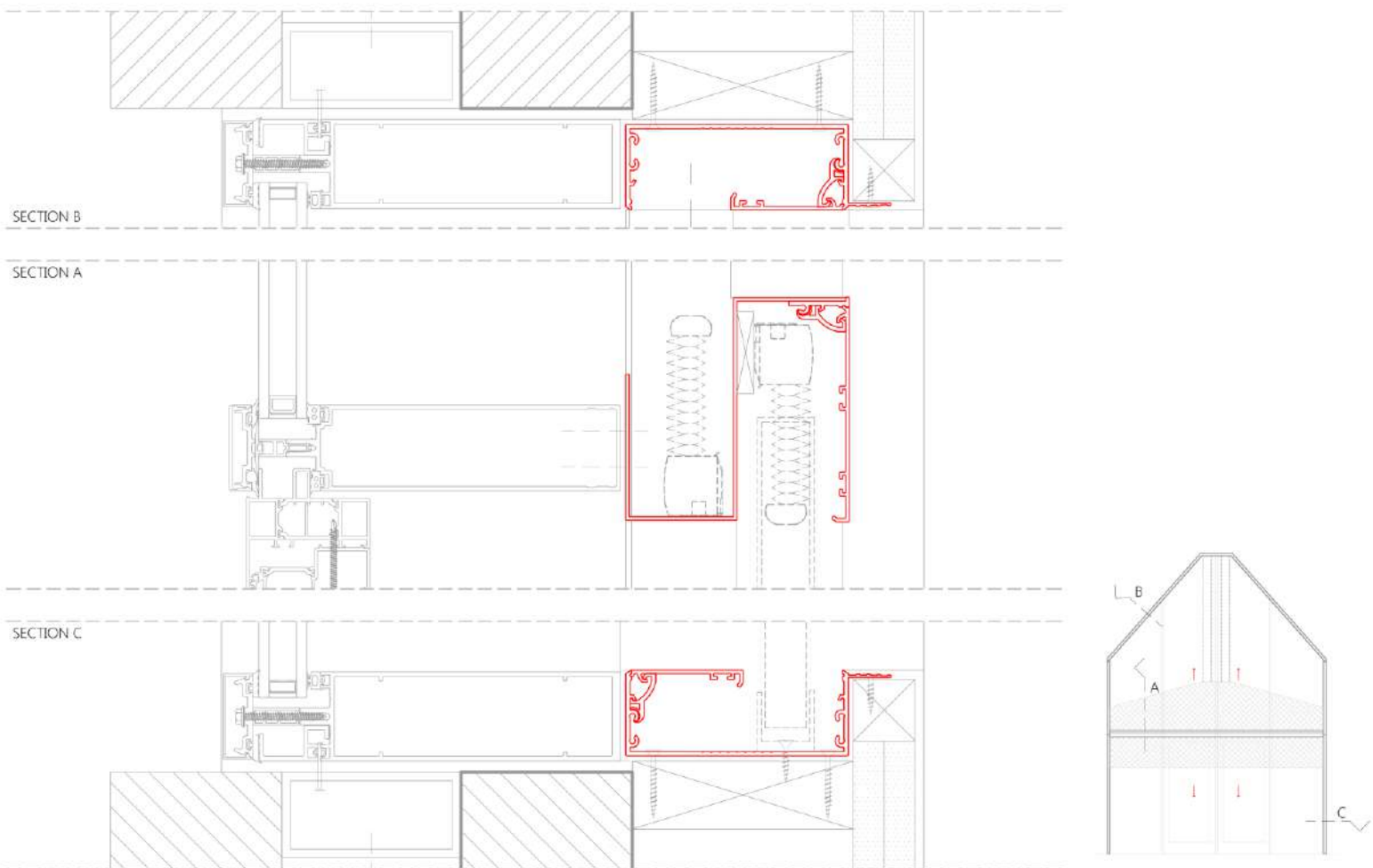

SHAPED BLINDS (Top-Down)



Specialist cellular blinds can also be concealed inside the sloping roof to be folded out when required. These specialist blinds can also be used in trapezoid windows combining a top fan triangle plus a straight lower section. Consult with a shading specialist early in your project to avoid structural elements to hinder a neat concealed blinds solution.

SAMPLE DRAWINGS

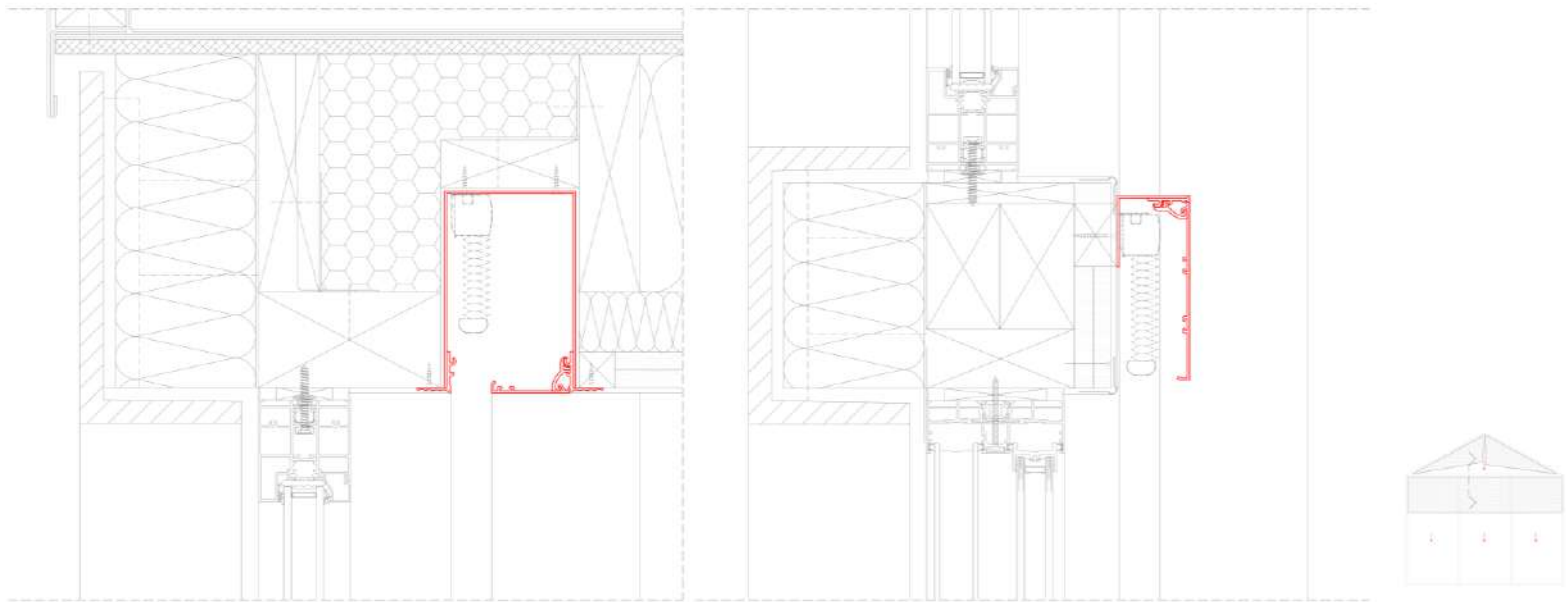

SKYLIGHT BLINDS (4-Sided Frame)

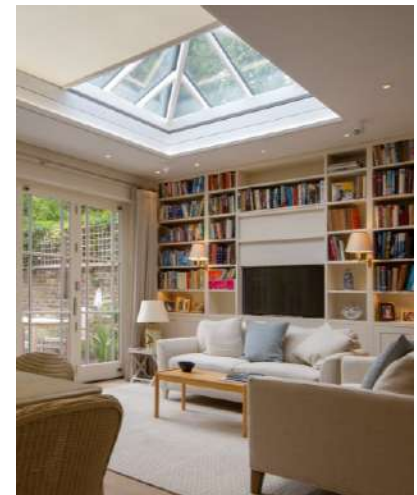

Blinds can be concealed in small roof windows as well as massive atrium skylights. The most common configuration is to have concealment boxes on all four sides of the window opening, with blinds installed in one end and side channels inside side boxes. When using concealment boxes on all sides of the window, the hem bar can be hidden in the opposite end to the blind system, leaving only fabric visible once the blind is deployed.

SAMPLE DRAWINGS

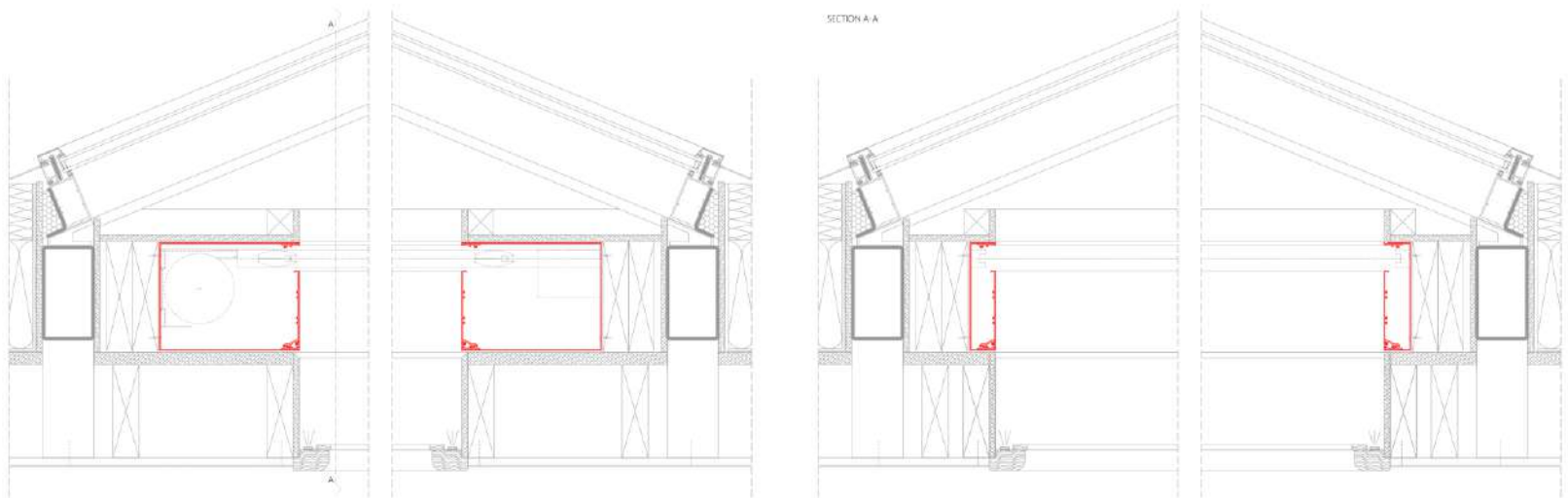

SKYLIGHT BLINDS (3-Sided Frame)



There are skylight blinds that can be hidden using head box and side boxes with no forth 'hem bar' box, leaving the hem bar visible when the blind is deployed. This configuration can for example be used in very long skylights with two blinds meeting in the middle or in wall-to-ceiling glazing with two blinds meeting in the corner.

SAMPLE DRAWINGS

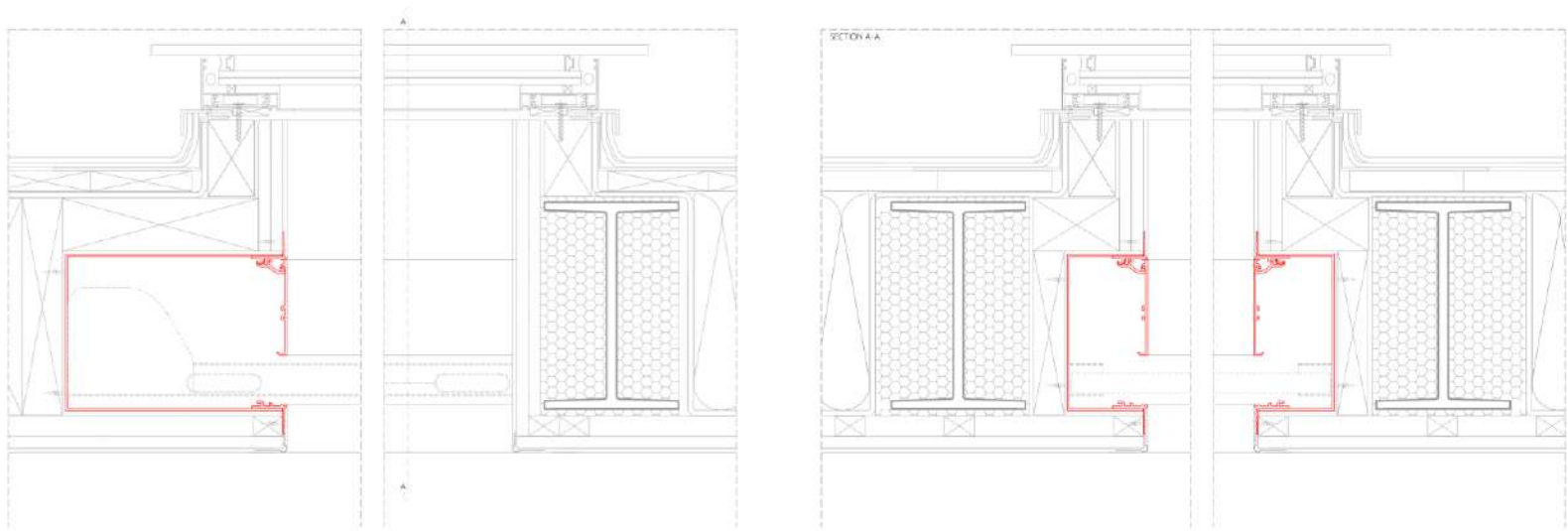

SPECIALTY BLINDS



Blindspace® concealment boxes can be made to any size to conceal blinds in any type of window. Shading specialists with local products can request bespoke boxes and pelmets and depending on the size of the products these can be custom fabricated in low volumes or extruded for large projects. Whatever the window, consider concealment at the earliest stage.

SAMPLE DRAWINGS

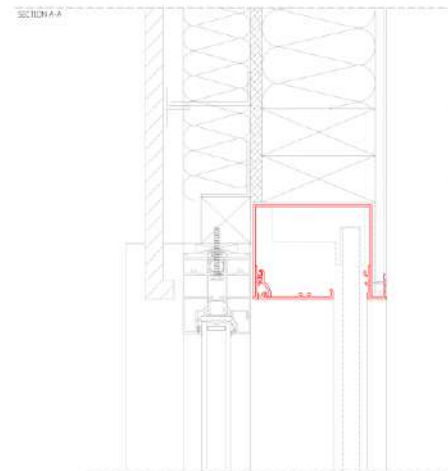
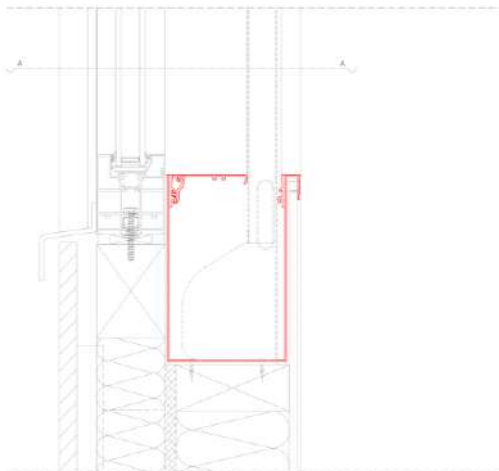
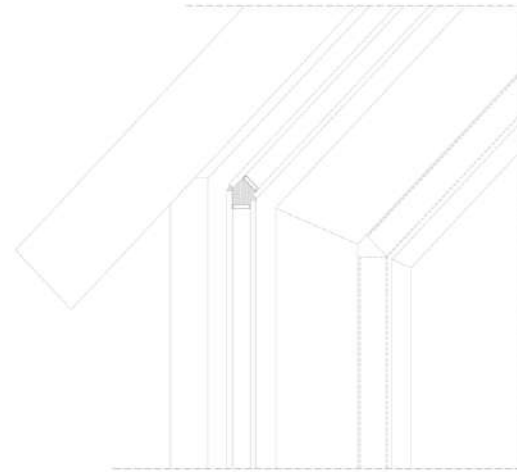
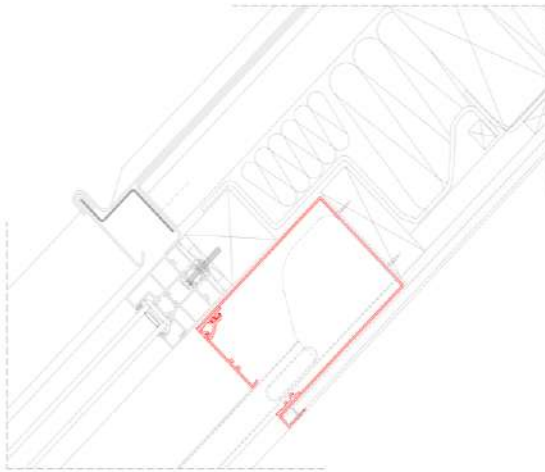

KEY PRODUCT FEATURES

STANDARD AND BESPOKE SIZES

Blinds of any type and size, single or dual, vertical or horizontal, can be concealed using Blindspace.

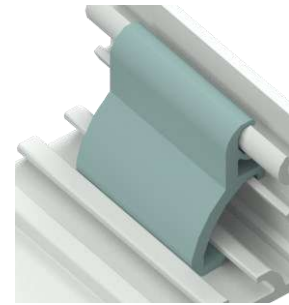
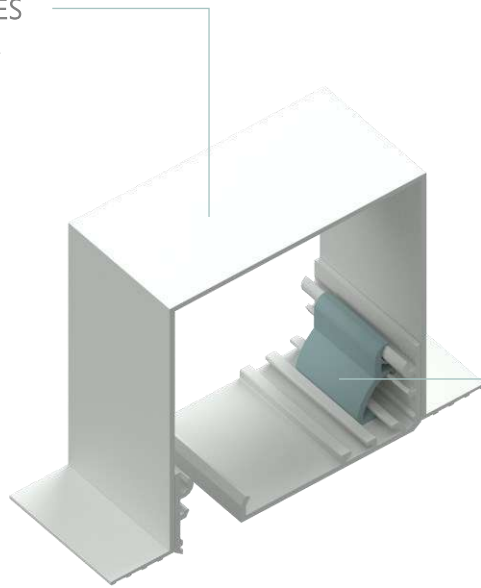

CLOSE WITH A CLICK

Patented closing mechanism providing unique features.

MULTIPLE BOX CORNER OPTIONS



No Flange



Upstand Flange



Skim Coat Flange



Perforated Flange



Visible Flange

FEATURES & BENEFITS

	FEATURES	BENEFITS
	Accessible space after construction is complete.	Concealed blinds can be installed and serviced at any time. No blinds involved during construction.
	Boxes available in standard and bespoke sizes.	Blinds of any type and size, single or dual, vertical or horizontal, can be concealed using Blindspace.
	Multiple box corner options available.	Boxes can be specified for any installation situation with no, plain, or skim coat flanges.
	Splice pins and splice plates to align boxes.	Two boxes and two covers can be spliced together for perfect alignment and end result.
	Covers available in standard and bespoke sizes.	The size of the opening gap can be designed to perfectly fit the blinds and bottom bar used.
	Covers can be made to fully close the box.	Windows can be prepared 'future-proofed' for potential future installation of concealed blinds.
	Covers shut with a click and stays in place.	Boxes can be installed in any direction for side channels, skylights or bottom-up blinds.
	Covers can be installed on either sides of the box.	Blinds can come out towards the window or towards the room, depending on preference.
	Covers are fixed with a safety hinge.	Cover can be opened and closed without the risk of the cover falling down from the ceiling.
	Powder coated to any colour or painted at site.	Boxes and covers can perfectly match the surrounding ceiling or wall.

FREQUENTLY ASKED QUESTIONS

QUESTION	ANSWER
What box dimensions do I need?	Box sizes depend on what you want to conceal. For standard roller blinds, 100x100mm is often used. For larger or dual blinds more space is required. Consult with your local shading specialist.
What is the smallest box size you can make?	We can make boxes 50x50mm however you would probably not find blinds that would fit and that would cover your window. Smallest useful boxes are 90x90mm with 90x50mm side boxes.
What is the largest box size you can make?	We can make boxes to any size and are frequently supplying boxes to house large skylight systems. Dual large blinds can also require very large boxes where blinds are either side by side or stacked.
Where can I find technical CAD drawings?	Blindspace provide technical CAD drawings in dwg and pdf formats on blindspace.com and platforms such as NBS. Blindspace clients may also have their own CAD drawings available.
Where and how do I buy Blindspace boxes?	Blindspace® boxes are sold through local shading specialists and AV companies that know what blinds are available locally and their size and wiring requirements.
Is it too late to incorporate into my project?	We are often contacted when construction work is completed and at that point visible boxes or pelmets may be the only way to hide blinds. The sooner this is considered the more options are available.
What is important to consider during installation?	Concealment boxes should be fixed through the back of the box and through the sides, through skim coat flanges every 200mm with scrim tape applied on flanges. See installation instructions.
How to 'activate' closed concealment boxes?	Contact your local shading specialist and they can measure and order new standard covers based on the blind gap required. Closed covers can also be cut down locally and powder coated.
What blinds can be installed inside?	Blindspace boxes are not limited to a specific blind or manufacturer. Motorised products are more common than manual ones for the complete minimalist and contemporary look and experience.
Where are motors for electric blinds located?	Electric roller blinds have the motor located inside the roller blind tube. Cellular type blinds have the motor located inside the head rail. No extra space is required in concealment boxes.

AVAILABLE RESOURCES

SHY BLINDS - Rooflight ZIP Roller Blinds

Lutron - Roller Blinds

SILENT GLISS

Model	Material	Width	Height	Weight	Box Size (L x W x H)	Box Volume	Box Weight
SHY ZIP	Aluminium	1000	1000	1.5	1100 x 1100 x 100	1331000	1.6
SHY ZIP	Aluminium	1500	1000	2.2	1600 x 1100 x 100	1936000	2.4
SHY ZIP	Aluminium	2000	1000	3.0	2100 x 1100 x 100	2541000	3.2
SHY ZIP	Aluminium	2500	1000	3.8	2600 x 1100 x 100	3146000	4.0
SHY ZIP	Aluminium	3000	1000	4.5	3100 x 1100 x 100	3751000	4.8
SHY ZIP	Aluminium	3500	1000	5.2	3600 x 1100 x 100	4356000	5.6
SHY ZIP	Aluminium	4000	1000	6.0	4100 x 1100 x 100	4961000	6.4
SHY ZIP	Aluminium	4500	1000	6.8	4600 x 1100 x 100	5566000	7.2
SHY ZIP	Aluminium	5000	1000	7.5	5100 x 1100 x 100	6171000	8.0
SHY ZIP	Aluminium	5500	1000	8.2	5600 x 1100 x 100	6776000	8.8
SHY ZIP	Aluminium	6000	1000	9.0	6100 x 1100 x 100	7381000	9.6
SHY ZIP	Aluminium	6500	1000	9.8	6600 x 1100 x 100	7986000	10.4
SHY ZIP	Aluminium	7000	1000	10.5	7100 x 1100 x 100	8591000	11.2
SHY ZIP	Aluminium	7500	1000	11.2	7600 x 1100 x 100	9196000	12.0
SHY ZIP	Aluminium	8000	1000	12.0	8100 x 1100 x 100	9801000	12.8
SHY ZIP	Aluminium	8500	1000	12.8	8600 x 1100 x 100	10406000	13.6
SHY ZIP	Aluminium	9000	1000	13.5	9100 x 1100 x 100	11011000	14.4
SHY ZIP	Aluminium	9500	1000	14.2	9600 x 1100 x 100	11616000	15.2
SHY ZIP	Aluminium	10000	1000	15.0	10100 x 1100 x 100	12221000	16.0

SIZE CHARTS

Recommended box sizes for popular blinds in different types and sizes.

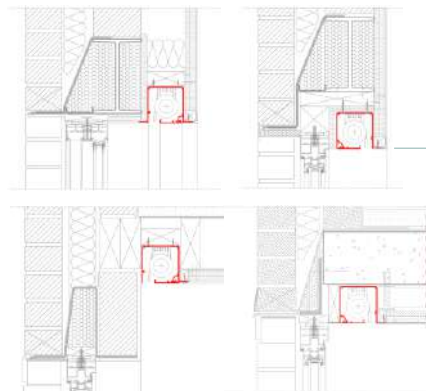

TECHNICAL DRAWINGS

Product and sample installation drawings in dwg and pdf formats.

PRODUCT SAMPLES

Sample kits available for architects, designers and shading specialists.



CPD TRAININGS

Blindspace offer RIBA accredited training sessions online or through local partners.

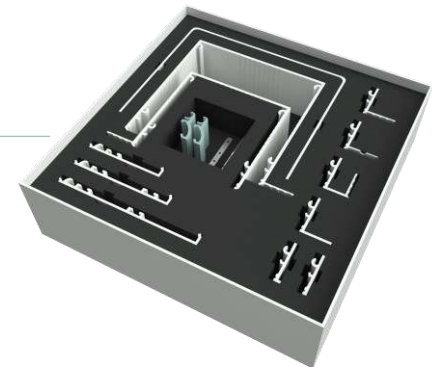

SYSTEM OVERVIEW

		S SERIES Standard	M SERIES Modular	C SERIES Custom
WINDOW TYPE	Windows & Doors	●	●	●
	Shaped Windows & Skylights			●
DIMENSIONS	Width x Height	100x100mm 130x130mm	100x100mm 130x130mm	Made to Measure
	Profile Length	6000 mm or cut to size	5000 mm or cut to size	3000 mm or cut to size
	Splice Together for Longer Lengths	●	●	●
MATERIAL	Box & Cover	2mm Extruded Alu	2-5 mm Extruded Alu	2mm Alu sheet Extruded Alu
	Cover Hinge	Polymer	Aluminium	Polymer
BOX CORNER	Skim Coat Flange	●	●	●
	Upstand Flange			●
	Visible Plain Flange		●	●
	Perforated Flange			●
	No Flange	●	●	●
COLOUR	White as Standard	●	●	●
	Black Inside		●	
	Any RAL Color	●	●	●



Standard S Series

Blindspace® S Series is a concealment box made to hide roller blinds with minimal visual impact. The box is installed during construction with the space accessible for blinds installation when the room is completed. It features the patented Blindspace® Safety Hinge that secures the cover in place and can be installed in any direction, allowing for side boxes to hide blind side channels or guide wires. Popular in floor-to-ceiling windows and sliding doors, S Series can be installed to future-proof buildings to have the option for later installation of concealed blinds.

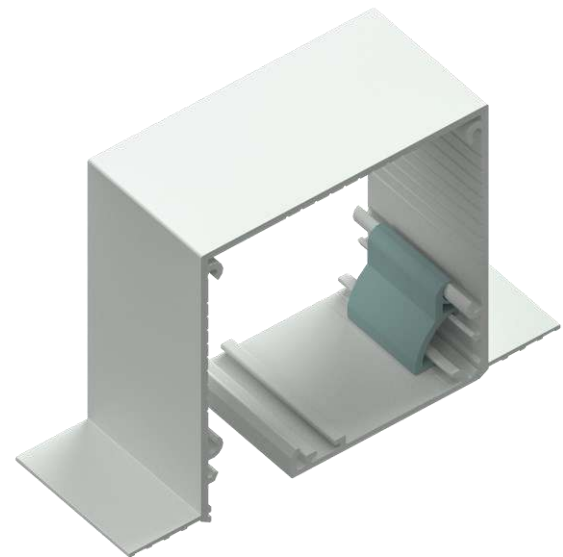

STANDARD S SERIES

S100x100 Headbox

Blinds up to ~2400 wide*
 * Blind sizes depend on blind products used, boxes provided up to 6000 wide.

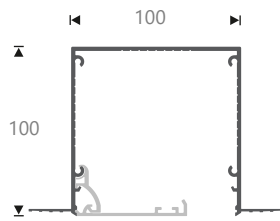

S130x130 Headbox

Blinds up to ~4000 wide*
 ZIP type blinds up to ~2500 wide*

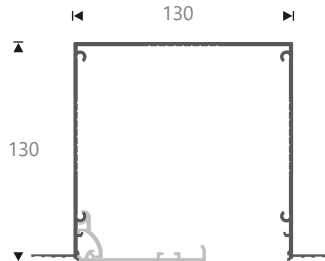

Accessories



Clip-on Hinge to connect boxes and cover flaps.
 Splice Pin to align and connect multiple boxes.
 Splice Plate to align multiple cover flaps.

S100x50 Sidebox

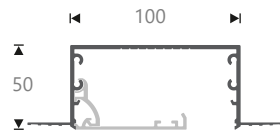

Cover	Opening
65mm	29mm
75mm	19mm
95mm	closed

S130x50 Sidebox



Cover	Opening
65mm	59mm
75mm	49mm
85mm	39mm
95mm	29mm
125mm	closed

End Caps

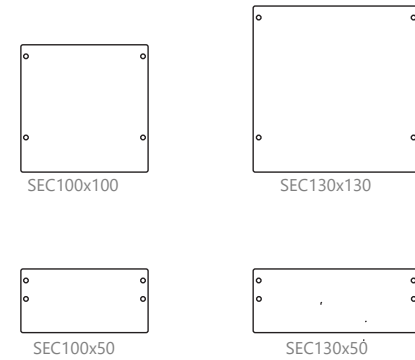

Box Corners

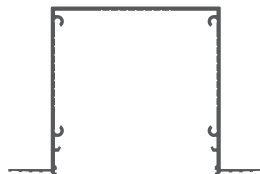

SS - Skim Coat Flanges on both sides
 EXAMPLE: S100x100SS

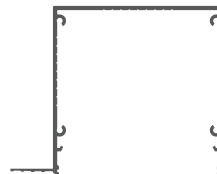

SN - Skim Coat Flange on one side
 EXAMPLE: S100x100SN

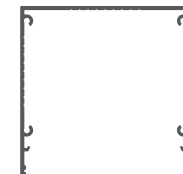

NN - No Flange
 EXAMPLE: S100x100NN



Modular M Series

Blindspace® M Series is a superior concealment box with black anodized interior to minimize light transmission and external faces powder coated to specified RAL colour. The box is installed during construction with the space accessible for blind installation when the room is completed. It features the patented Blindspace® Safety Hinge that secures the cover in place and can be installed in any direction, allowing for side boxes to hide blind side channels or guide wires. Popular in floor-to-ceiling windows and sliding doors, M Series can be installed to future-proof buildings to have the option to install concealed blinds in the future.

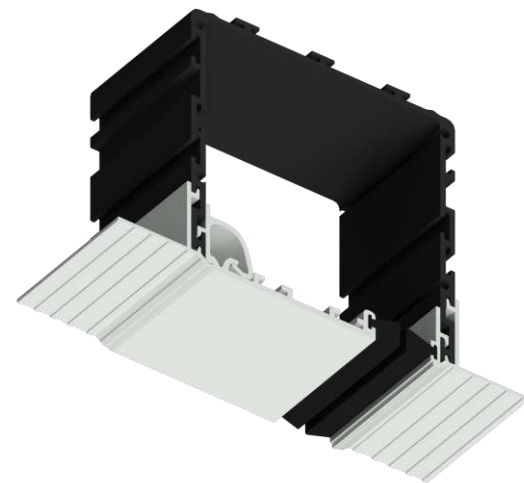

MODULAR M SERIES

M100x100 Headbox

blinds up to ~2500 wide*

* blind sizes depend on blind products used, boxes provided up to 5000 wide.

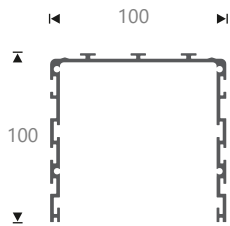

M130x130 Headbox

blinds up to ~3900 wide*
zip blind up to ~2800 wide*

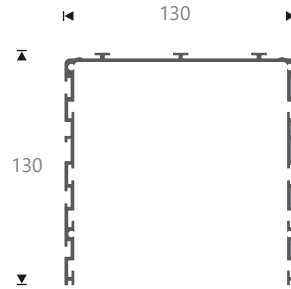

M100x70 Sidebox

for side channel up to 60mm deep

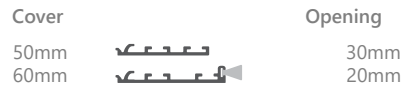
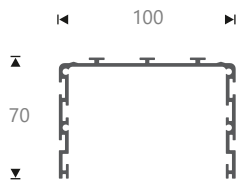

M100x70 Sidebox

for side channel up to 60mm deep

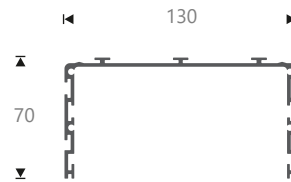

Accessories

Corner Flanges



Side Covers

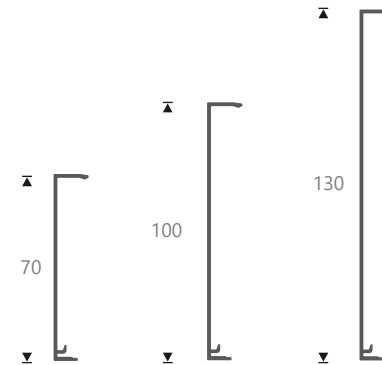

Box Configurations

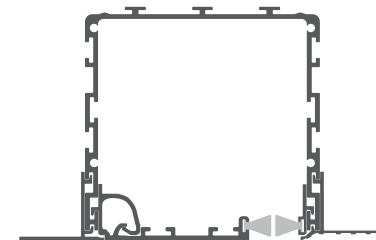
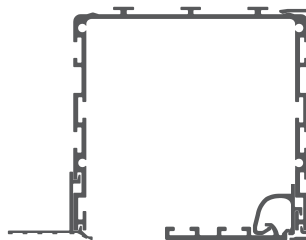
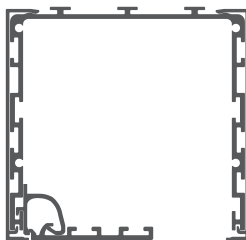



Custom C Series

Blindspace® C Series boxes can be made to any size, to conceal all types of blinds, achieving minimal visual impact. The box is installed during construction with the space accessible for blind installation once the room is completed. It features the patented Blindspace® Safety Hinge that secures the cover in place and can be installed in any direction, together with side boxes to hide blind side channels and/or guide wires. Custom C Series boxes are used for very large blinds, double blinds, gable blinds and skylight blinds. C Series boxes can also be installed to future-proof buildings to have the option to install concealed blinds later.

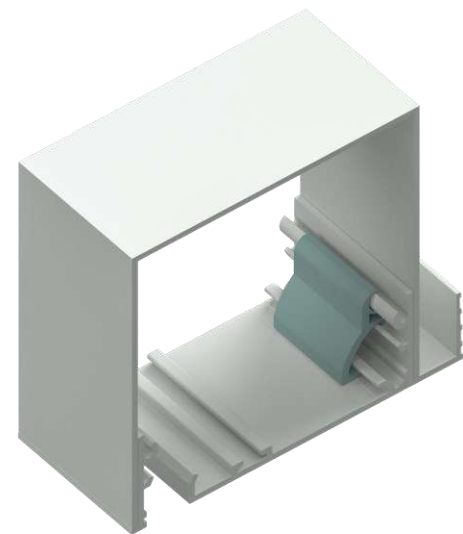

CUSTOM C SERIES

Custom Head Box

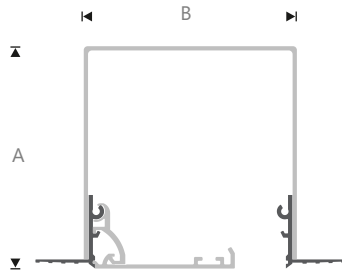

Custom Side Box

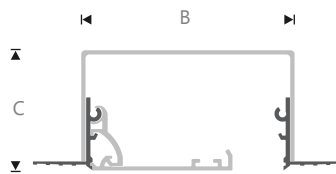

Accessories



Clip-on Hinge

Splice Pin

Splice Plate

Clip-on Hinge to connect boxes and cover flaps.
Splice Pin to align and connect multiple boxes.
Splice Plate to align multiple cover flaps.

Box Corners



S - Skim coat flange.



U - Upstand flange.



V - Visible plain flange.



N - No flange.



P - Perforated flange.

Cover Flaps

Cover

65mm	
75mm	
85mm	
95mm	
115mm	
125mm	
150mm	
200mm	

Custom End Cap

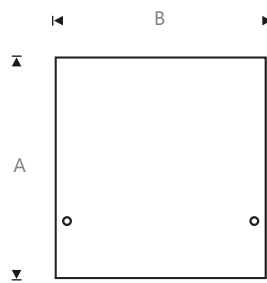

Example C125x105SN Headbox

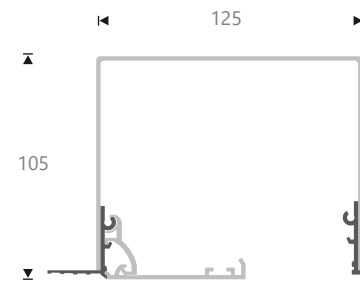

BACKGROUND

Blindspace came to life when founder Gaius Guest, Director of Grants Blinds in London, recognized the need of architects and designers, to conceal blinds in any type of window, door, gable and skylight.

Blindspace was created in Sweden with the objective to design architectural solutions that make blinds and curtain tracks disappear into walls and ceilings.

GET IN TOUCH

We are happy to answer any question you may have or forward you to one of our many local partners. We work with selected Blinds and AV companies around the world and we assist architects, designers, property developers, glazing companies, contractors and home owners to conceal blinds and recess curtain tracks, in their projects.

Are you interested in becoming a local partner? Do you operate a Blinds or AV company with excellent client reviews? Get in touch to learn more!

CALL **+44 20 8798 3945 (UK)**
see webpage for more numbers

EMAIL **SALES@BLINDSPACE.COM**

WEBPAGE **BLINDSPACE.COM**

SOCIAL      

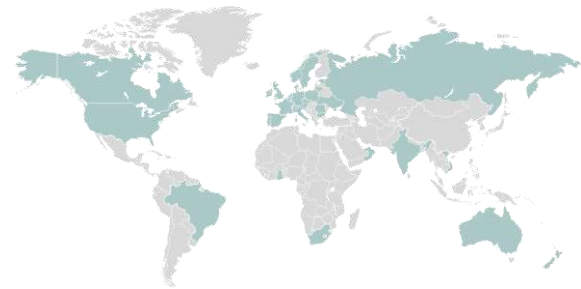

ESTABLISHED
2016

200+
CLIENTS

25+
MARKETS

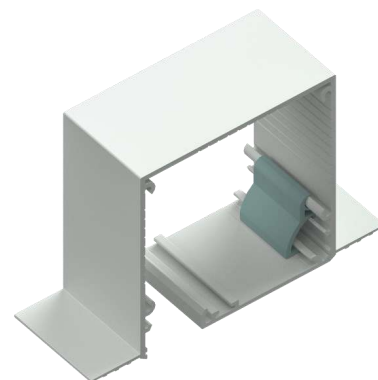

DESIGNED TO DISAPPEAR